

FILED
07 JUL 12 PM 3:12
RECEIVED BY: WIKING
CLERK U.S. DISTRICT COURT
NORTHERN DISTRICT OF CALIFORNIA

1 TOWNSEND AND TOWNSEND AND CREW LLP
2 GREGORY S. GILCHRIST (Bar # 111536)
3 GIA L. CINCONI (Bar # 141668)
4 Two Embarcadero Center, 8th Floor
5 San Francisco, California 94111
6 Telephone: (415) 576-0200
7 Facsimile: (415) 576-0300
8 Email: gsgilchrist@townsend.com, glcinconi@townsend.com

E-Filing

9 Attorneys for Plaintiff
10 LEVI STRAUSS & CO.

11 UNITED STATES DISTRICT COURT
12 FOR THE NORTHERN DISTRICT OF CALIFORNIA

MEJ

13 **C 07 3612**

14 LEVI STRAUSS & CO.,
15 Plaintiff,
16 v.
17 POLO RALPH LAUREN CORPORATION,
18 Defendant.

19 Case No.
20 **COMPLAINT FOR TRADEMARK
21 INFRINGEMENT, UNFAIR
22 COMPETITION AND DILUTION
23 (INJUNCTIVE RELIEF SOUGHT)**
24 **JURY TRIAL DEMAND**

25 Plaintiff Levi Strauss & Co. ("LS&CO.") complains against defendant Polo Ralph Lauren Corporation ("PRL") as follows:

26 **JURISDICTION, VENUE AND INTRA-DISTRICT ASSIGNMENT**

27 1. Plaintiff's first, second and third claims arise under the Trademark Act of 1946 (the Lanham Act), as amended by the Federal Trademark Dilution Act of 1995 (15 U.S.C. §§ 1051, et seq.). This Court has jurisdiction over such claims pursuant to 28 U.S.C. §§ 1338(a) and 1338(b) (trademark and unfair competition), 28 U.S.C. § 1331 (federal question) and 15 U.S.C. § 1121 (Lanham Act). This Court has supplemental jurisdiction over the remaining state law claims under 28 U.S.C. § 1367.

28 2. LS&CO. is informed and believes that venue is proper in this Court under 28 U.S.C. § 1391(b) because Defendant transacts affairs in this district and because a substantial part of the events giving rise to the claims asserted arose in this district.

1 3. Intra-district assignment to any division of the Northern District is proper under Local
2 Rule 3-2(c) and the Assignment Plan of this Court as an "Intellectual Property Action."

3 **PARTIES**

4 4. LS&CO. is a Delaware corporation with its principal place of business at Levi's Plaza,
5 1155 Battery Street, San Francisco, California 94111. Operating since approximately the 1850's,
6 LS&CO. is one of the oldest and most well known apparel companies in the world. It manufactures,
7 markets and sells a variety of apparel, including its traditional denim blue jean products.

8 5. LS&CO. is informed and believes that defendant Polo Ralph Lauren Corporation is a
9 New York corporation with its principal place of business at 650 Madison Avenue, New York, New
10 York 10022. LS&CO. is informed and believes that PRL manufactures, distributes or sells or has
11 manufactured, distributed or sold a line of clothing, including jeans, under the brand name POLO
12 RALPH LAUREN which is offered for sale and sold in this judicial district. LS&CO. is further
13 informed and believes that PRL has authorized, directed, and/or actively participated in the wrongful
14 conduct alleged herein.

15 **FACTS AND ALLEGATIONS COMMON TO ALL CLAIMS**

16 **LS&CO.'s Use Of Its Trademarks**

17 6. LS&CO. marks its LEVI'S® brand products with a set of trademarks that are famous
18 around the world. For many years prior to the events giving rise to this Complaint and continuing to
19 the present, LS&CO. annually has spent great amounts of time, money, and effort advertising and
20 promoting the products on which its trademarks are used and has sold many millions of these products
21 all over the world, including throughout the United States and in California. Through this investment
22 and large sales, LS&CO. has created considerable goodwill and a reputation for quality products.
23 LS&CO. continuously has used these trademarks, some for well over a century, to distinguish its
24 products.

25 7. Most of LS&CO.'s trademarks are federally registered; all are in full force and effect,
26 and exclusively owned by LS&CO. LS&CO. continuously has used each of its trademarks, from the
27 registration date or earlier, until the present and during all time periods relevant to LS&CO.'s claims.
28

1 **LS&CO.'s Arcuate Stitching Design Trademark**

2 8. Among its marks, LS&CO. owns the famous Arcuate Stitching Design Trademark (the
3 "Arcuate trademark"), which consists of a distinctive pocket stitching design that is the oldest known
4 apparel trademark in the United States. LS&CO. has used the Arcuate trademark continuously since
5 1873 in interstate commerce on clothing products. LS&CO. first used the Arcuate trademark on jeans
6 and later used it on trousers, pants, shorts, skirts, shirts and jackets. Examples of LS&CO.'s use of the
7 Arcuate trademark on LEVI'S® jeans are attached as Exhibit A.

8 9. LS&CO. owns, among others, the following United States and California Registrations
9 for its Arcuate trademark, attached as Exhibit B:

10 a. U.S. Registration No. 404,248 (first used as early as 1873; registered November
11 16, 1943).

12 b. U.S. Registration No. 1,139,254 (first used as early as 1873; registered
13 September 2, 1980);

14 These registrations have become incontestable under the provisions of 15 U.S.C. § 1065.

15 c. U.S. Registration No. 2,791,156 (first used as early as September 1, 1936;
16 registered December 9, 2003)

17 d. U.S. Registration No. 2,794,649 (first used as early as 1873; registered
18 December 16, 2003.)

19 e. California Registration No. 088399 (first used as early as 1873; registered
20 August 24, 1988).

21 10. The Arcuate trademark is famous and is recognized around the world and throughout
22 the United States by consumers as signifying a high quality LEVI'S® product.

23 **PRL's Infringement of LS&CO.'s Arcuate Trademark**

24 11. LS&CO. is informed and believes that PRL has in the past and continues to
25 manufacture, source, market and/or sell clothing that displays stitching designs that are confusingly
26 similar to LS&CO.'s Arcuate trademark, including but not limited to the designs shown in Exhibit C
27 (the "Ralph Lauren stitching designs").

28 12. PRL USA Holdings, Inc. has filed an application with the United States Patent and

1 Trademark Office ("PTO") to register one of the Ralph Lauren stitching designs. That application,
2 Serial Number 78/863,658, is currently pending with the PTO; LS&CO. has filed a Notice of
3 Opposition to registration of the proposed mark.

4 13. LS&CO. is informed and believes that PRL has manufactured, marketed and sold
5 substantial quantities of products bearing the Ralph Lauren stitching designs, and has obtained and
6 continues to obtain substantial profits thereby.

7 14. PRL's actions as alleged herein have caused and will cause LS&CO. irreparable harm
8 for which money damages and other remedies are inadequate. Unless PRL is restrained by this Court,
9 it will continue and/or expand the illegal activities alleged in this Complaint and otherwise continue to
10 cause great and irreparable damage and injury to LS&CO. by, among other things:

- 11 a. Depriving LS&CO. of its statutory rights to use and control use of its
- 12 trademark;
- 13 b. Creating a likelihood of confusion, mistake and deception among consumers
- 14 and the trade as to the source of the infringing products;
- 15 c. Causing the public falsely to associate LS&CO. with PRL and/or its products,
- 16 or vice versa;
- 17 d. Causing incalculable and irreparable damage to LS&CO.'s goodwill and
- 18 diluting the capacity of its Arcuate trademark to differentiate LEVI'S® products
- 19 from others; and
- 20 e. Causing LS&CO. to lose sales of its genuine clothing products.

21 15. Accordingly, in addition to other relief sought, LS&CO. is entitled to preliminary and
22 permanent injunctive relief against PRL and all persons acting in concert with it.

23 **FIRST CLAIM**
24 **FEDERAL TRADEMARK INFRINGEMENT**
25 **(15 U.S.C. §§ 1114-1117; Lanham Act § 32)**

26 16. LS&CO. realleges and incorporates by reference each of the allegations contained in
27 paragraphs 1 through 15 of this Complaint.

28 17. Without LS&CO.'s consent, PRL has used, in connection with the sale, offering for

1 sale, distribution or advertising of its products, designs that infringe upon LS&CO.'s registered
2 Arcuate trademark.

3 18. These acts of trademark infringement have been committed with the intent to cause
4 confusion, mistake, or deception, and are in violation of 15 U.S.C. § 1114.

5 19. As a direct and proximate result of PRL's infringing activities, LS&CO. has suffered
6 substantial damage.

7 20. PRL's infringement of LS&CO.'s trademark as alleged herein is an exceptional case
8 and was intentional, entitling LS&CO. to treble its actual damages and to an award of attorneys' fees
9 under 15 U.S.C. §§ 1117(a) and 1117(b).

10 **SECOND CLAIM**
11 **FEDERAL UNFAIR COMPETITION**
12 **(False Designation of Origin and False Description)**
13 **(15 U.S.C. § 1125(a); Lanham Act § 43(a))**

14 21. LS&CO. realleges and incorporates by reference each of the allegations contained in
15 paragraphs 1 through 20 of this Complaint.

16 22. PRL's conduct constitutes the use of symbols or devices tending falsely to describe the
17 infringing products, within the meaning of 15 U.S.C. § 1125(a)(1). PRL's conduct is likely to cause
18 confusion, mistake, or deception by or in the public as to the affiliation, connection, association,
19 origin, sponsorship or approval of the infringing products to the detriment of LS&CO. and in violation
20 of 15 U.S.C. § 1125(a)(1).

21 23. As a direct and proximate result of PRL's infringing activities, LS&CO. has suffered
22 substantial damage.

23 **THIRD CLAIM**
24 **FEDERAL DILUTION OF FAMOUS MARK**
25 **(Federal Trademark Dilution Act of 1995)**
26 **(15 U.S.C. § 1125(c); Lanham Act § 43(c))**

27 24. LS&CO. realleges and incorporates by reference each of the allegations contained in
28 paragraphs 1 through 23 of this Complaint.

29 25. LS&CO.'s Arcuate trademark is distinctive and famous within the meaning of the
Federal Trademark Dilution Act of 1995, 15 U.S.C. § 1125(c), as amended.

1 26. PRL's activities as alleged herein, both separately and collectively, have diluted or are
2 likely to dilute the distinctive quality of LS&CO.'s trademark in violation of the Federal Trademark
3 Dilution Act of 1995, 15 U.S.C. § 1125(c), as amended.

4 27. LS&CO. is entitled to injunctive relief pursuant to 15 U.S.C. § 1125(c).

5 28. Because PRL willfully intended to trade on LS&CO.'s reputation and/or to cause
6 dilution of LS&CO.'s famous trademark, LS&CO. is entitled to damages, extraordinary damages, fees
7 and costs pursuant to 15 U.S.C. § 1125(c)(2).

8 **FOURTH CLAIM**
9 **CALIFORNIA DILUTION AND TRADEMARK INFRINGEMENT**
10 **(Cal. Bus. & Prof. Code §§ 14320, 14330, 14335, 14340)**

11 29. LS&CO. realleges and incorporates by reference each of the allegations contained in
12 paragraphs 1 through 28 of this Complaint.

13 30. PRL's infringement of LS&CO.'s federal and state registered trademark is likely to
14 cause consumer confusion and dilution of LS&CO.'s trademark in violation of California Business &
15 Professions Code Sections 14320, 14330, and 14335.

16 31. PRL infringed and diluted LS&CO.'s Arcuate trademark with knowledge and intent to
17 cause confusion, mistake or deception.

18 32. PRL's conduct is aggravated by that kind of willfulness, wantonness, malice and
19 conscious indifference to the rights and welfare of LS&CO. for which California law allows the
20 imposition of exemplary damages.

21 33. Pursuant to California Business & Professions Code § 14340, LS&CO. is entitled to
22 injunctive relief and damages in the amount of three times PRL's profits and three times all damages
23 suffered by LS&CO. by reason of PRL's manufacture, use, display or sale of infringing goods.

24 **FIFTH CLAIM**
25 **CALIFORNIA UNFAIR COMPETITION**
26 **(Cal. Bus. & Prof. Code § 17200)**

27 34. LS&CO. realleges and incorporates by reference each of the allegations contained in
28 paragraphs 1 through 33 of this Complaint.

35. PRL's infringement of LS&CO.'s Arcuate trademark constitutes "unlawful, unfair or
fraudulent business act[s] or practice[s] and unfair, deceptive, untrue or misleading advertising" within

1 the meaning of California Business & Professions Code Section 17200.

2 36. As a consequence of PRL's actions, LS&CO. is entitled to injunctive relief and an
3 order that PRL disgorge all profits on the manufacture, use, display or sale of infringing goods.

4 **PRAYER FOR JUDGMENT**

5 WHEREFORE, LS&CO. prays that this Court grant it the following relief:

6 37. Adjudge that LS&CO.'s Arcuate trademark has been infringed by PRL in violation of
7 LS&CO.'s rights under common law, 15 U.S.C. § 1114, and/or California law;

8 38. Adjudge that PRL has competed unfairly with LS&CO. in violation of LS&CO.'s rights
9 under common law, 15 U.S.C. § 1125(a), and/or California law;

10 39. Adjudge that PRL's activities are likely to, or have, diluted LS&CO.'s famous Arcuate
11 trademark in violation of LS&CO.'s rights under common law, 15 U.S.C. § 1125(c), and/or California
12 law;

13 40. Adjudge that PRL and its agents, employees, attorneys, successors, assigns, affiliates,
14 and joint venturers and any person(s) in active concert or participation with it, and/or any person(s)
15 acting for, with, by, through or under it, be enjoined and restrained at first during the pendency of this
16 action and thereafter permanently from:

17 a. Manufacturing, producing, sourcing, importing, selling, offering for sale,
18 distributing, advertising, or promoting any goods that display any words or symbols that so resemble
19 LS&CO.'s Arcuate trademark as to be likely to cause confusion, mistake or deception, on or in
20 connection with any product that is not authorized by or for LS&CO., including without limitation any
21 product that bears the Ralph Lauren stitching designs which are the subject of this Complaint and for
22 which PRL is responsible, or any other approximation of LS&CO.'s Arcuate trademark;

23 b. Using any word, term, name, symbol, device or combination thereof that causes
24 or is likely to cause confusion, mistake or deception as to the affiliation or association of PRL or its
25 products with LS&CO. or as to the origin of PRL's goods, or any false designation of origin, false or
26 misleading description or representation of fact;

27 c. Further infringing the rights of LS&CO. in and to any of its trademarks in its
28 LEVIT'S® brand products or otherwise damaging LS&CO.'s goodwill or business reputation;

1 d. Otherwise competing unfairly with LS&CO. in any manner; and

2 e. Continuing to perform in any manner whatsoever any of the other acts

3 complained of in this Complaint;

4 41. Adjudge that PRL be required immediately to supply LS&CO.'s counsel with a
5 complete list of individuals and entities from whom or which it purchased, and to whom or which it
6 sold, offered for sale, distributed, advertised or promoted, infringing products as alleged in this
7 Complaint;

8 42. Adjudge that PRL be required immediately to deliver to LS&CO.'s counsel its entire
9 inventory of infringing products, including without limitation pants and any other clothing, packaging,
10 labeling, advertising and promotional material and all plates, patterns, molds, matrices and other
11 material for producing or printing such items, that are in its possession or subject to its control and that
12 infringe LS&CO.'s Arcuate trademark as alleged in this Complaint;

13 43. Adjudge that PRL, within thirty (30) days after service of the judgment demanded
14 herein, be required to file with this Court and serve upon LS&CO.'s counsel a written report under
15 oath setting forth in detail the manner in which it has complied with the judgment;

16 44. Adjudge that LS&CO. recover from PRL its damages and lost profits in an amount to
17 be proven at trial;

18 45. Adjudge that PRL be required to account for any profits that are attributable to its
19 illegal acts, and that LS&CO. be awarded the greater of (1) three times PRL's profits or (2) three times
20 any damages sustained by LS&CO., under 15 U.S.C. § 1117, plus prejudgment interest;

21 46. Order an accounting of and impose a constructive trust on all of PRL's funds and assets
22 that arise out of his infringing activities;

23 47. Direct the PTO to refuse registration to Trademark Application Serial Number
24 78/863,658;

25 48. Adjudge that LS&CO. be awarded its costs and disbursements incurred in connection
26 with this action, including LS&CO.'s reasonable attorneys' fees and investigative expenses; and

27 ///

28 ///

1 49. Adjudge that all such other relief be awarded to LS&CO. as this Court deems just and
2 proper.

3
4 DATED: July 12, 2007

Respectfully submitted,

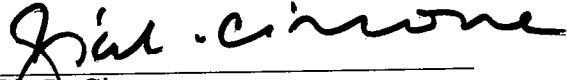
5
6 By: 

7 Gia L. Cincone
8 TOWNSEND AND TOWNSEND AND CREW LLP
9 Two Embarcadero Center, Eighth Floor
San Francisco, California 94111
Telephone: (415) 576-0200
Facsimile: (415) 576-0300

10 Attorneys for Plaintiff
11 LEVI STRAUSS & CO.
12
13
14
15
16
17
18
19
20
21
22
23
24
25
26
27
28

1
2
3
4
5
6
7
8
9
10
11
12
13
14
15
16
17
18
19
20
21
22
23
24
25
26
27
28

DEMAND FOR JURY TRIAL

LS&CO. demands that this action be tried to a jury.

DATED: July 12, 2007

Respectfully submitted,

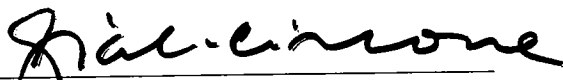
By: 

Gia L. Cincone
TOWNSEND AND TOWNSEND AND CREW LLP
Two Embarcadero Center, Eighth Floor
San Francisco, California 94111
Telephone: (415) 576-0200
Facsimile: (415) 576-0300

Attorneys for Plaintiff
LEVI STRAUSS & CO.

Exhibit A



Exhibit A-1



Exhibit A-2



Exhibit A-3

Exhibit B



428326



THE UNITED STATES OF AMERICA

**TO ALL TO WHOM THESE PRESENTS SHALL COME:
UNITED STATES DEPARTMENT OF COMMERCE**

United States Patent and Trademark Office

July 16, 2001

THE ATTACHED U.S. TRADEMARK REGISTRATION 404,248 IS CERTIFIED TO BE A TRUE COPY WHICH IS IN FULL FORCE AND EFFECT WITH NOTATIONS OF ALL STATUTORY ACTIONS TAKEN THEREON AS DISCLOSED BY THE RECORDS OF THE UNITED STATES PATENT AND TRADEMARK OFFICE.

REGISTERED FOR A TERM OF 20 YEARS FROM *November 16, 1943*
2nd RENEWAL FOR A TERM OF 20 YEARS FROM *November 16, 1983*

SECTION 8 & 15

REPUBLISHED SECTION 12C

SAID RECORDS SHOW TITLE TO BE IN:

STRAUSS, LEVI & CO.



By Authority of the
COMMISSIONER OF PATENTS AND TRADEMARKS

H. Phillips
H. PHILLIPS
Certifying Officer

Registered Nov. 16, 1943

Trade-Mark 404,248

Republished, under the Act of 1946, April 27, 1948, by
Levi Strauss & Company, San Francisco, Calif.

Affidavit under Section 8 accepted.

Affidavit under Section 15 received, Aug. 31, 1953.

UNITED STATES PATENT OFFICE

Levi Strauss & Company, San Francisco, Calif.

Act of February 20, 1905

Application September 25, 1942, Serial No. 455,769

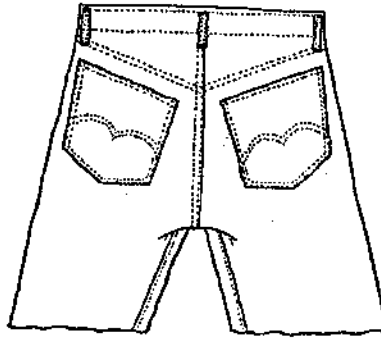

STATEMENT

To the Commissioner of Patents:

Levi Strauss & Company, a corporation duly organized under the laws of the State of California and located at the city and county of San Francisco, State of California, and doing business at 98 Battery Street, San Francisco, California, has adopted and used the trade-mark shown in the accompanying drawing, for WAISTBAND TYPE OVERALLS, in Class 39, Clothing, and presents herewith five facsimiles showing the trade-mark as actually used by applicant upon the goods, and requests that the same be registered in the United States Patent Office in accordance with act of February 20, 1905. The trade-mark has been continuously used and applied to said goods in applicant's business since the year 1873. The trade-mark consists of double arcuate designs of orange color displayed on the hip pockets of the overalls as shown on the drawing. The mark is applied to the overalls

by stitching the double arcuate designs on the hip pockets with orange colored thread, or by painting the lines of said design on the hip pockets with orange colored paint.

No claim is made to the exclusive use of the representation of a pair of overalls.

The undersigned hereby appoints Castberg & Roemer, a firm composed of Thomas Castberg and Irving C. Roemer, whose address is 807 Crocker Building, San Francisco, California, and whose registration number is 15,030, as its attorneys, with full power of substitution and revocation, to prosecute this application, to make alterations and amendments therein, to receive the certificate of registration, and to transact all business in the Patent Office connected therewith.

LEVI STRAUSS & COMPANY,
By DANIEL E. KOSHLAND,
Vice President.

438326

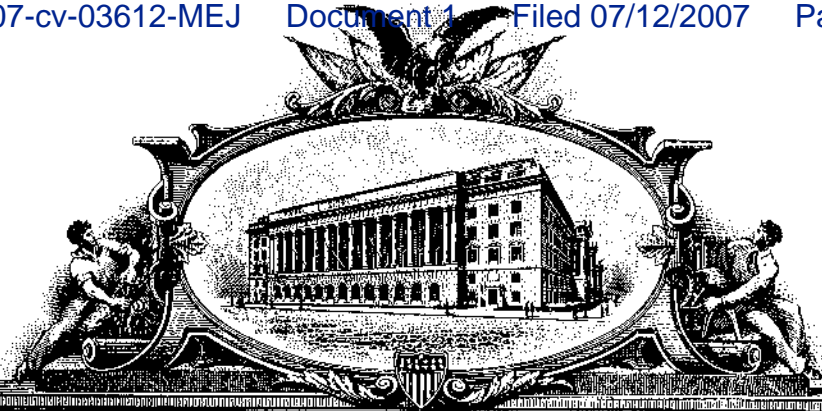

THE UNITED STATES OF AMERICA

TO ALL TO WHOM THESE PRESENTS SHALL COME:

UNITED STATES DEPARTMENT OF COMMERCE

United States Patent and Trademark Office

July 16, 2001

THE ATTACHED U.S. TRADEMARK REGISTRATION 1,139,254 IS CERTIFIED TO BE A TRUE COPY WHICH IS IN FULL FORCE AND EFFECT WITH NOTATIONS OF ALL STATUTORY ACTIONS TAKEN THEREON AS DISCLOSED BY THE RECORDS OF THE UNITED STATES PATENT AND TRADEMARK OFFICE.

REGISTERED FOR A TERM OF 20 YEARS FROM *September 02, 1980*

SECTION 8 & 15

SAID RECORDS SHOW TITLE TO BE IN:

LEVI STRAUSS & CO.

A DE CORP



**By Authority of the
COMMISSIONER OF PATENTS AND TRADEMARKS**

H. Phillips
H. PHILLIPS
Certifying Officer

Int. Cl.: 25

Prior U.S. Cl.: 39

Reg. No. 1,139,254

United States Patent and Trademark Office

Registered Sep. 2, 1980

TRADEMARK

Principal Register

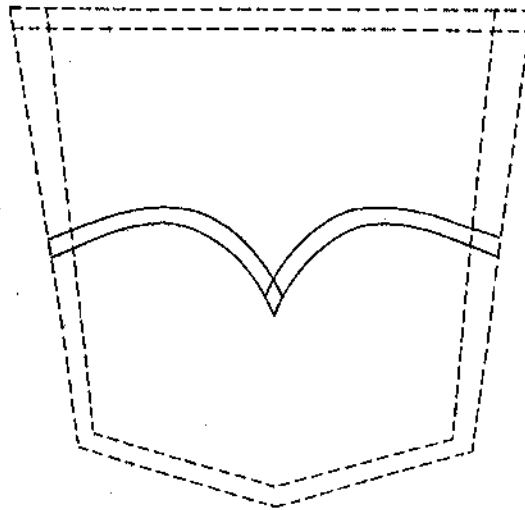

Levi Strauss & Co. (Delaware corporation)
Two Embarcadero Ctr.
San Francisco, Calif. 94106

For: PANTS, JACKETS, SKIRTS, DRESSES AND
SHORTS, in CLASS 25 (U.S. CL. 39).
First use 1873; in commerce 1873.
Owner of U.S. Reg. No. 404,248.

Ser. No. 169,399. Filed May 8, 1978.

M. J. LEAHY, Primary Examiner



UNITED STATES DEPARTMENT OF COMMERCE
Patent and Trademark Office
OFFICE OF ASSISTANT COMMISSIONER FOR TRADEMARKS
2900 Crystal Drive
Arlington, Virginia 22202-3513

REGISTRATION NO: 1139254 SERIAL NO: 73169399 MAILING DATE: 08/06/2001
REGISTRATION DATE: 09/02/1980
MARK: MISCELLANEOUS DESIGN
REGISTRATION OWNER: LEVI STRAUSS & CO.
CORRESPONDENCE ADDRESS:

SARAH R. FULLER
LEGAL STRATEGIES GROUP
5905 CHRISTIE AVENUE
EMERYVILLE, CA 94608-1925

NOTICE OF ACCEPTANCE

15 U.S.C. Sec. 1058(a)(3)

THE COMBINED AFFIDAVIT AND RENEWAL APPLICATION FILED FOR THE ABOVE-IDENTIFIED REGISTRATION MEETS THE REQUIREMENTS OF SECTION 8 OF THE TRADEMARK ACT, 15 U.S.C. Sec. 1058.

ACCORDINGLY, THE SECTION 8 AFFIDAVIT IS ACCEPTED.

NOTICE OF RENEWAL

15 U.S.C. Sec. 1059(a)

THE COMBINED AFFIDAVIT AND RENEWAL APPLICATION FILED FOR THE ABOVE-IDENTIFIED REGISTRATION MEETS THE REQUIREMENTS OF SECTION 9 OF THE TRADEMARK ACT, 15 U.S.C. Sec. 1058.

ACCORDINGLY, THE REGISTRATION IS RENEWED.

THE REGISTRATION WILL REMAIN IN FORCE FOR CLASS(ES):
025.

HARPER, BARBARA A
PARALEGAL SPECIALIST
POST-REGISTRATION DIVISION
(703)308-9500

PLEASE SEE THE REVERSE SIDE OF THIS NOTICE FOR INFORMATION CONCERNING REQUIREMENTS FOR MAINTAINING THIS REGISTRATION

7006650



THE UNITED STATES OF AMERICA

TO ALL TO WHOM THESE PRESENTS SHALL COME:

UNITED STATES DEPARTMENT OF COMMERCE

United States Patent and Trademark Office

April 06, 2006

**THE ATTACHED U.S. TRADEMARK REGISTRATION 2,791,156 IS
CERTIFIED TO BE A TRUE COPY WHICH IS IN FULL FORCE AND
EFFECT WITH NOTATIONS OF ALL STATUTORY ACTIONS TAKEN
THEREON AS DISCLOSED BY THE RECORDS OF THE UNITED STATES
PATENT AND TRADEMARK OFFICE.**

REGISTERED FOR A TERM OF 10 YEARS FROM *December 09, 2003*

SAID RECORDS SHOW TITLE TO BE IN:

LEVI STRAUSS & CO.

A DELAWARE CORPORATION

**By Authority of the
Under Secretary of Commerce for Intellectual Property
and Director of the United States Patent and Trademark Office**

L. Edelen

**L. EDELEN
Certifying Officer**



Int. Cl.: 25

Prior U.S. Cls.: 22 and 39

United States Patent and Trademark Office

Reg. No. 2,791,156

Registered Dec. 9, 2003

**TRADEMARK
PRINCIPAL REGISTER**

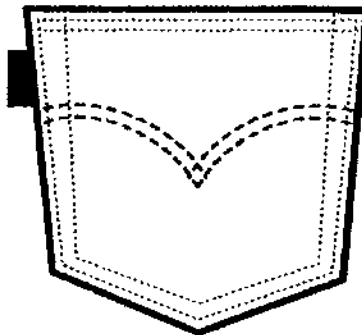

LEVI STRAUSS & CO. (DELAWARE CORPORATION)
1155 BATTERY STREET
SAN FRANCISCO, CA 94111

FOR: PANTS, JEANS, SHORTS, SHIRTS, T-SHIRTS, BLOUSES, SKIRTS AND JACKETS, IN CLASS 25 (U.S. CLS. 22 AND 39).

FIRST USE 9-1-1936; IN COMMERCE 9-1-1936.

OWNER OF U.S. REG. NOS. 1,041,846, 1,135,196, AND 1,139,254.

THE LINING AND SHADING SHOWN IN THE DRAWING ARE FEATURES OF THE MARK AND NOT INTENDED TO INDICATE COLOR.

THE MARK CONSISTS OF THE COMBINATION OF A DOUBLE ARCUATE AND TAB DESIGN SHOWN ON THE SHAPE OF A POCKET, AS INDICATED BY A SOLID LINE.

SER. NO. 78-144,339, FILED 7-16-2002.

ELLEN B. AWRICH, EXAMINING ATTORNEY

7096689



THE UNITED STATES OF AMERICA

TO ALL TO WHOM THESE PRESENTS SHALL COME:

UNITED STATES DEPARTMENT OF COMMERCE

United States Patent and Trademark Office

April 06, 2006

THE ATTACHED U.S. TRADEMARK REGISTRATION 2,794,649 IS CERTIFIED TO BE A TRUE COPY WHICH IS IN FULL FORCE AND EFFECT WITH NOTATIONS OF ALL STATUTORY ACTIONS TAKEN THEREON AS DISCLOSED BY THE RECORDS OF THE UNITED STATES PATENT AND TRADEMARK OFFICE.

REGISTERED FOR A TERM OF 10 YEARS FROM *December 16, 2003*

SAID RECORDS SHOW TITLE TO BE IN:

LEVI STRAUSS & CO.

A DELAWARE CORPORATION

By Authority of the
Under Secretary of Commerce for Intellectual Property
and Director of the United States Patent and Trademark Office

L. EDELEN
Certifying Officer



Int. Cl.: 25

Prior U.S. Cls.: 22 and 39

United States Patent and Trademark Office

Reg. No. 2,794,649

Registered Dec. 16, 2003

**TRADEMARK
PRINCIPAL REGISTER**



LEVI STRAUSS & CO. (DELAWARE CORPORATION)
1155 BATTERY STREET
SAN FRANCISCO, CA 94111

THE MARK CONSISTS OF A DOUBLE ARCUATE DESIGN.

FOR: PANTS, JEANS, SHORTS, SHIRTS, T-SHIRTS, BLOUSES, SKIRTS AND JACKETS, IN CLASS 25 (U.S. CLS. 22 AND 39).

SER. NO. 78-142,765, FILED 7-10-2002.

FIRST USE 0-0-1873; IN COMMERCE 0-0-1873.

GINNY ISAACSON, EXAMINING ATTORNEY

State of California

SECRETARY OF STATE

Trademark Reg. No. 88399 Class No. Int. 25 Renewal No. 15637
CERTIFICATE OF RENEWAL OF TRADEMARK

I, BILL JONES, Secretary of State of the State of California, hereby certify:

That an application for renewal has been filed in this office for the TRADEMARK described below:

Name of Applicant: Levi Strauss & Co.
Business Address: 1155 Battery Street San Francisco, CA 94111
Date First Used in California: 1873
Date First Used Anywhere: 1873
Description of Trademark: Arc Design. Design of two concentric arcs placed in such a manner that they meet in the center
Description of Goods on Which the Trademark is Used: Pants, shirts, and jackets
Date of Registration: August 24, 1988
Term of Registration Extends to and Includes: August 24, 2008

**IN WITNESS WHEREOF, I execute
this certificate and affix the Great
Seal of the State of California this
6th day of July, 1998**



Bill Jones
BILL JONES
Secretary of State



State of California

Secretary of State

RENEWAL OF TRADEMARK OR SERVICE MARK

Pursuant to Business and Professions Code Section 14250

(APPLICATION FOR RENEWAL MUST BE RECEIVED BY THE SECRETARY OF STATE WITHIN (BUT NOT BEFORE) THE SIX-MONTH PERIOD PRIOR TO THE DATE OF EXPIRATION OF THE CURRENT REGISTRATION TOGETHER WITH RENEWAL FEE.)

SEND THE SIGNED APPLICATION WITH ORIGINAL SIGNATURE(S) TO THE SECRETARY OF STATE, TRADEMARK UNIT, P.O. BOX 944225, SACRAMENTO, CA 94244-2250.

RENEWAL APPLICATION FOR: TRADEMARK SERVICE MARK

1. NAME OF APPLICANT:
LEVI STRAUSS & CO.

2. STREET ADDRESS: (DO NOT GIVE P. O. BOX) (FOR SERVICE MARK, PROVIDE CALIFORNIA BUSINESS ADDRESS)
1155 Battery Street

CITY: San Francisco	STATE: CA	ZIP CODE 94111
-------------------------------	---------------------	--------------------------

3. BUSINESS STRUCTURE: (CHECK ONE)

<input type="checkbox"/> LIMITED PARTNERSHIP	<input type="checkbox"/> SOLE PROPRIETOR
<input type="checkbox"/> LIMITED LIABILITY COMPANY	<input type="checkbox"/> UNINCORPORATED ASSOCIATION
<input type="checkbox"/> GENERAL PARTNERSHIP	<input type="checkbox"/> HUSBAND AND WIFE, AS COMMUNITY PROPERTY
<input checked="" type="checkbox"/> CORPORATION (STATE OF INCORPORATION) <u>Delaware</u>	<input type="checkbox"/> OTHER (DESCRIBE) _____

4. IF PARTNERSHIP, LIST NAMES OF PARTNERS	5. NAMES OF MEMBER(S) OR MANAGER(S), IF APPLICANT IS A LIMITED LIABILITY COMPANY
---	--

6. NAME AND/OR DESCRIPTION OF TRADE/SERVICE MARK: **A device created by two concentric arcs placed on pockets in such a manner that they meet in the center thereof, usually applied by stitching. Arc DESIGN.**

7. TRADE/SERVICE MARK REGISTRATION NUMBER 088399	8. DATE OF REGISTRATION August 24, 1988
--	---

THE MARK WAS ADOPTED, USED, AND CONTINUES TO BE USED WITHIN THE STATE OF CALIFORNIA BY THE APPLICANT IN THE FORM AND MANNER SPECIFIED IN THE PRESENT REGISTRATION.

9. NAME OF CORPORATION/PARTNERSHIP/LIMITED LIABILITY COMPANY (IF APPLICABLE)
LEVI STRAUSS & CO.

THIS SPACE FOR FILING OFFICER USE

TRADE/SERVICE MARK

REG. NO. 88399

RENEWAL NO. 015637

SIGNATURE (IF PARTNER OR CORPORATE OFFICER, INCLUDE TITLE.)

DATE

10. RETURN ACKNOWLEDGMENT TO: (TYPE OR PRINT)

NAME	[Sarah R. Fuller]	
ADDRESS	Legal Strategies Group	
	5905 Christie Avenue	
CITY	Emeryville, CA 94608-1925	
STATE		
ZIP CODE		

FILED
In the office of the Secretary of State
of the State of California

JUL - 6 1998

Bill Jones
BILL JONES, Secretary of State

ARC 10021B



SEP 01 1988

Office of

SEP 01 1988

March Fong Eu

Secretary of State
SACRAMENTO

As Secretary of State, it is my pleasure to notify you that the mark you submitted has been registered in this office.

Please be advised that Section 14220(f) of the Business and Professions Code specifies that a mark shall not be registered if it so resembles a mark or trade name already registered or used in this state by another and not abandoned, as to be likely, when applied to the goods or services of the applicant, to cause confusion or mistake or to deceive.

My office has conducted a search of California trademark and service mark registrations. Your mark does not appear to resemble any previous registration.

Please be advised, however, that there may be unregistered marks or California trade names used by corporations and partnerships, fictitious names, and names under which individuals conduct business which may resemble your registration. A check for such names is beyond the scope of the review of this office in registering marks.

Most sincerely,

March Fong Eu
MARCH FONG EU



State of California

OFFICE OF THE SECRETARY OF STATE



Trademark
Reg. No. 088399

CERTIFICATE OF REGISTRATION OF TRADEMARK

I, MARCH FONG EU, Secretary of State of the State of California, hereby certify:

That in accordance with the application filed in this office the TRADEMARK described below has been duly registered in this office on behalf of:

Name of Applicant LEVI STRAUSS & CO.

Business Address 1155 Battery Street
San Francisco, CA 94111

Date First Used in California 1873

Date First Used Anywhere 1873

Description of Trademark A device created by two concentric arcs placed on pockets in such a manner that they meet in the center thereof, usually applied by stitching.

Class No. 39

Description of Goods on Which the Trademark is Used Pants, shirts and jackets

A copy, specimen, facsimile, counterpart or a reproduction of the mark is attached.

Date of Registration August 24, 1988

Term of Registration Extends to and Includes August 24, 1998

IN WITNESS WHEREOF, I execute this certificate and affix the Great Seal of the State of California this

24th day of August, 1988

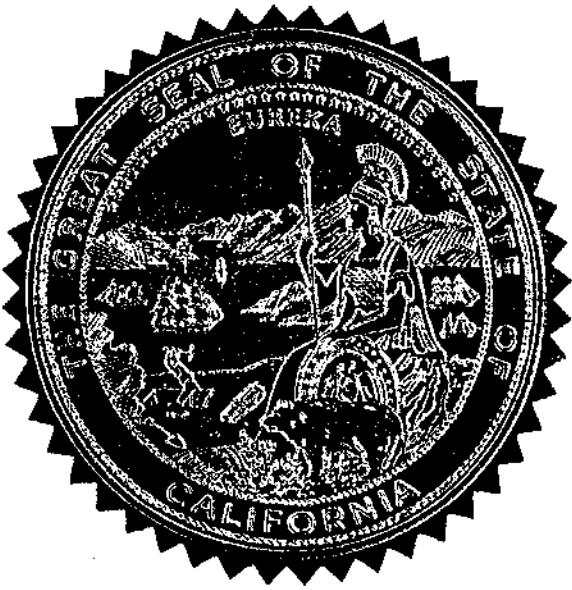

March Fong Eu
Secretary of State

A COPY, SPECIMEN, FACSIMILE, COUNTERPART OR
REPRODUCTION OF TRADEMARK REG. NO. 088399

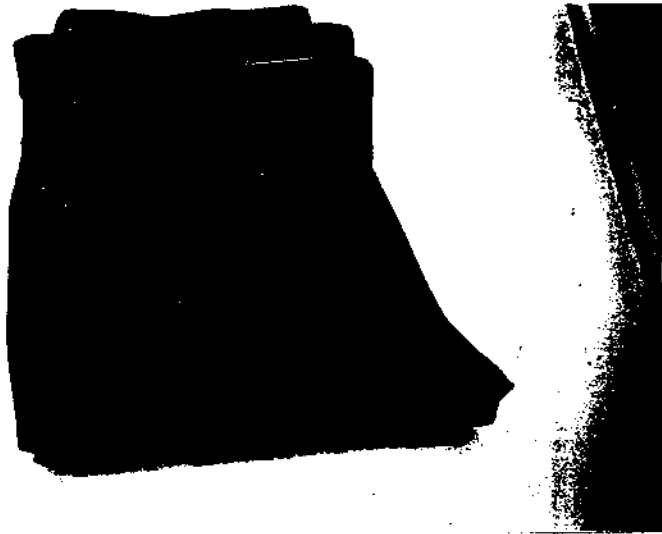



APPLICATION TO REGISTER A TRADEMARK
IN THE STATE OF CALIFORNIA

TO: MARCH FONG EU
Secretary of State
923 12th Street, Suite 301
Sacramento, California 95814
(916) 445-9872

Trademark
Reg. No. 088399
Class No. 39

FILED
in the office of the Secretary of State
of the State of California
AUG 24 1988
March Fong Eu
MARCH FONG EU
SECRETARY OF STATE

Applicant requests registration of the trademark described below and submits the following information along with the registration fee of \$50.00:

1. Name of Applicant LEVI STRAUSS & CO.

CHECK ONE: Sole Proprietor Corporation
 Limited Partnership General Partnership
 Unincorporated Association
 Husband and Wife, as community property
 Other (Describe) _____

2. Business Address, City, State 1155 Battery Street, San Francisco, CA 94111

3. State of Incorporation, if applicant is a corporation Delaware

4. Names of the general partners, if applicant is a partnership _____

5. Description of the Trademark. The trademark consists of the following:
A device created by two concentric arcs placed on pockets in such a manner
that they meet in the center thereof, usually applied by stitching.

6. The specific goods, products, or merchandise (stock-in-trade) which the applicant(s) sell(s) to the customers, and on which the trademark is used, are/is as follows:
pants, shirts and jackets

7. The trademark has previously been used, and is now being used on said goods in the State of California as follows:

- On labels and tags affixed to the goods.
- On labels and tags affixed to containers of the goods.
- By printing it directly onto the goods.
- By printing it directly onto the containers for the goods.

8. Enclosed as specimens or facsimiles are:

- Five identical actual labels.
- Five identical actual tags.
- Five identical photographs of the goods/containers showing the trademark thereon.
- Five entire front panels of a paper container bearing the trademark.

9. The date the trademark was first used in California is 1873.

The date the trademark was first used anywhere is 1873.

The applicant is the owner of the mark and no other person has the right to use such mark in the State of California either in the identical form thereof or in such near resemblance thereto as might be calculated to deceive or to be mistaken therefor.

LEVI STRAUSS & CO.

Type name of corporation or partnership on above line (leave above line blank if sole proprietor)

BY

Tracy MacLeod
Signature of applicant, partner, officer of corporation; if partner, so state and if officer, set forth title of office
Tracy MacLeod, Assistant Secretary

VERIFICATION

Tracy MacLeod

declares under penalty of perjury under the laws of the State of California that the statements contained in the foregoing application are true of his/her own knowledge.

DATED: June 30, 1988

BY

Tracy MacLeod
Signature of applicant, partner, officer of corporation; if partner, so state and if officer, set forth title of office

T/M 88 399



Exhibit C



Exhibit C-1



Exhibit C-2